



CS 1200



User and Installation Guide

# Notice

No part of this publication may be reproduced, stored in a retrieval system, translated to another language, or transmitted in any form by any means, electronic, mechanical, photocopied, recorded, or otherwise, without prior written permission.

The information in this document is subject to change. Neither Carestream Dental LLC nor any of its subsidiaries shall be liable for errors contained herein or for incidental damages in conjunction with the furnishing, performance, or use of this material.

We recommend that you thoroughly familiarize yourself with this Guide in order to make the most effective use of your system.



**WARNING: We recommend that you consult the “Safety Sheet” and the “Safety and Regulatory Guide” before using the CS 1200 Systems.**

All trademarks and registered trademarks are the property of their respective holders.

The CS 1200 is intended for professional use only.

US Federal law restricts this device to sale by or on the order of a dentist.

Manual Name: *CS 1200 Intraoral Camera User and Installation Guide*

Part Number: 9H1809

Revision Number: 06

Print Date: 2019-02



# Contents

<b>Chapter 1</b>	Conventions in This Guide . . . . .	1
<b>Conventions in This Guide</b>		
<b>Chapter 2</b>	CS 1200 System Description . . . . .	3
<b>CS 1200 System Packaging</b>	Packaging of the CS 1200 Camera . . . . .	3
<b>Chapter 3</b>	Camera Overview. . . . .	5
<b>CS 1200 Intraoral Camera Overview</b>		
<b>Chapter 4</b>	Minimum Computer System Requirements . . . . .	7
<b>CS 1200 Software Overview</b>	General Software Overview . . . . .	7
	CS 1200 Acquisition Interface Overview . . . . .	7
	Toolbar Overview . . . . .	8
	Video Toolbar . . . . .	8
	Image Toolbar . . . . .	8
	Common Video and Image Toolbar. . . . .	8
	Image Gallery Toolbar. . . . .	9
	Monitor Connection Overview. . . . .	9
	Transfer Toolbar . . . . .	9
	Select Patient Dialog Box. . . . .	9
	Dialog Boxes Overview . . . . .	10
	Image Processing Dialog Box. . . . .	10
	Tooth Chart Dialog Box . . . . .	10
	Select a Format Dialog Box. . . . .	11
	Preferences Dialog Boxes Overview . . . . .	12
	General Preferences . . . . .	12
	Video Adjustment Preferences . . . . .	13
	Tools Preferences . . . . .	13
<b>Chapter 5</b>	Connecting the Camera to a Computer and Installing	
<b>Setting Up the</b>	the Software . . . . .	15
<b>CS 1200 Intraoral</b>	Installing the Camera Holder. . . . .	16
<b>Camera</b>	Camera Holder Components Overview. . . . .	16
	Installing the Camera Holder . . . . .	16

<b>Chapter 6</b>	Accessing the Acquisition Interface . . . . .	19
<b>Getting Started</b>	Setting Up Preferences . . . . .	19
	Using the Imaging Software with TWAIN. . . . .	19
	Starting the Imaging Software . . . . .	19
	Setting Up Preferences. . . . .	20
<b>Chapter 7</b>	Preparing for Acquisition . . . . .	21
<b>Recording Video</b>	Preparing the Camera . . . . .	21
<b>and Capturing</b>	Acquiring Live Video or Images . . . . .	22
<b>Images on a</b>	Accessing the Acquisition Interface . . . . .	22
<b>Computer</b>	Recording or Viewing a Video . . . . .	22
	Capturing and Viewing Images. . . . .	23
<b>Chapter 8</b>	Cleaning and Disinfecting the Camera . . . . .	25
<b>Maintenance</b>		
<b>Chapter 9</b>	CS 1200 Troubleshooting Instructions . . . . .	27
<b>Troubleshooting</b>		
<b>Chapter 10</b>	Manufacturer's Address . . . . .	29
<b>Contact Information</b>	Authorized Representatives . . . . .	29

# 1

## Conventions in This Guide

### Conventions in This Guide

The following messages emphasize information or indicate potential risk to personnel or equipment:



**WARNING:** Warns you to avoid injury to yourself or others by following the safety instructions precisely.



**CAUTION:** Alerts you to a condition that might cause serious damage.



**Important:** Alerts you to a condition that might cause problems.



**Note:** Emphasizes important information.



**Tip:** Provides extra information and hints.



# 2 CS 1200 System Packaging



## CS 1200 System Description

The CS 1200 system is available in a wired USB configuration.

See “Packaging of the CS 1200 Camera” for the packaging components list. Inspect the packages of the CS 1200 intraoral camera after the shipment is received. If there are any signs of damage or missing parts, contact the shipping company and Carestream Dental LLC immediately.

## Packaging of the CS 1200 Camera

Table 1 Packaging of the CS 1200 Camera

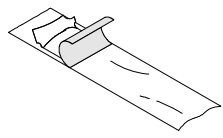
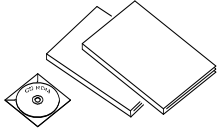
Component	Description	Quantity
	CS 1200 camera	1
	Camera holder	1
	USB cable	1
	Protective sheaths	10
	Document and software package: <i>CS Intraoral Cameras Installation Wizard DVD</i> <i>Documents on DVD:</i> <ul style="list-style-type: none"><li>• User and Installation Guide</li><li>• Safety, Regulatory, and Technical Specifications User Guide</li><li>• Safety Information Sheet</li><li>• Quick Start Guide</li></ul> <i>Documents Printed:</i> <ul style="list-style-type: none"><li>• Warranty Sheet</li><li>• Quick Start Guide</li><li>• Safety Information Sheet</li></ul>	





# 3 CS 1200 Intraoral Camera Overview

The CS 1200 intraoral camera is an easy-to-use, simple-to-share, and high-quality imaging system.



When connected to a computer, it has the following functions:

- Recording videos
- Capturing images
- Reviewing recorded videos and captured images

## Camera Overview

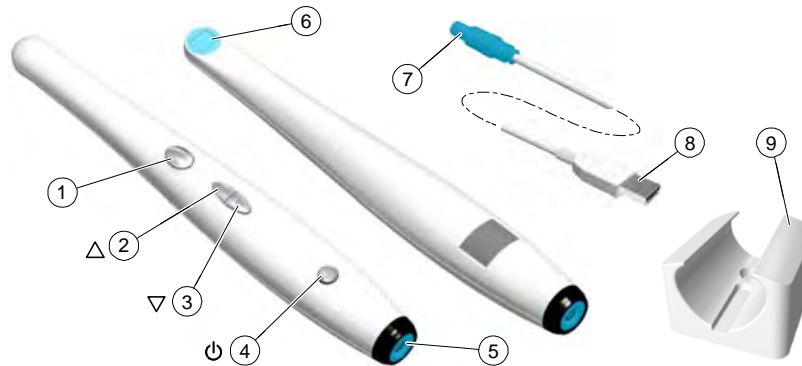
Figure 1 Camera Components Overview



- |    |                                   |  |
|----|-----------------------------------|--|
| 1  | Capture button                    | Press to capture an image.   |
| 2  | Review button (backward)          | Press to view the previous image.  |
| 3  | Review button (forward)           | Press to view the next image.  |
| 4  | Power button (LED indicator)      | <ul style="list-style-type: none"><li>• Press 3 seconds to power ON.</li><li>• Press 3 seconds to power OFF.</li><li>• Press 1 second to turn OFF the LED of the lens window.</li><li>•  indicates the power is ON.</li><li>•  indicates the power is OFF.</li></ul> |
| 5  | Cable connection                  | USB  |
| 6  | Camera lens                       |  |
| 7  | Push-pull connector               |  |
| 8  | USB connector                     |  |
| 9  | Camera holder                     |  |
| 10 | Protective sheaths (not pictured) |  |



# 4 CS 1200 Software Overview

## Minimum Computer System Requirements

For the minimum computer system requirements, see the **CS 1200 Safety, Regulatory, and Technical Specifications User Guide**.



**Important:** It is **MANDATORY** to check that your computer system configuration is compatible with the computer system requirements for the CS 1200 software.

## General Software Overview

The CS 1200 intraoral imaging system operates with the following software:

- **CS Imaging Software**
- Imaging software using a TWAIN interface
- CS 1200 **Acquisition** interface

## CS 1200 Acquisition Interface Overview

The CS 1200 **Acquisition** interface can acquire, review, and store videos and images of the oral cavity.

**Figure 2 Acquisition Interface Overview**



- 1 **Title Bar:** Displays the patient's name.
- 2 **Toolbar:** See "Toolbar Overview" on page 8.
- 3 **View Screen:** Displays live video, selected captured image, or recorded video.
- 4 **Image Gallery:** Displays thumbnails of all captured images and recorded videos.

## Toolbar Overview

The **Toolbar** enables you to manage the following features:

- Live video recording, viewing, and managing features.
- Image capturing, viewing, and managing features.

### Video Toolbar

The video toolbar enables you to launch, record, and play a live or recorded video.



**Video record** button: Records a live video.



**Play** button: Plays a recorded video.



**Pause** button: Pauses a recorded video.



**Stop** button: Stops a recorded video.

### Image Toolbar

The image toolbar enables you to capture, view, and manage a still image.



**Capture** button: Captures an image.



**Reset** button: Clears all changes made to an image.



**Rotation** button: Rotates an image 45°.



**Rotation** button: Rotates an image 90°.

### Common Video and Image Toolbar

The following buttons are shared by the video and image screens:



**Live video** button: Launches the live video.





**Review** button: Reviews images and recorded videos.



**Tooth chart comment** button: Accesses the tooth chart dialog box to associate a tooth/teeth with the selected image and enables you to write comments in the **Comments** field.



**Select a format** button: Click  to access the last selected format. Click  to access the **Select a format** dialog box to select a new display format.



**Mirror image and Video** button: Mirrors the live video and the captured images.



**Full screen** button: Displays the live video, recorded video, and the captured images in full screen.



**Exit button:** Closes the acquisition interface.



**USB connection status icon:** Displays the camera USB connection status. If the icon is red, the USB is disconnected.



**Preference button:** Accesses the **Preferences** dialog box.



**Information button:** Accesses information on software version, firmware version, and camera serial number.



**Online help button:** Accesses the online help.

### Image Gallery Toolbar

The image gallery toolbar enables you to manage videos and images displayed in the image gallery.



**Scroll button:** Scrolls images and recorded videos in the image gallery.



**Delete button:** Deletes selected images and recorded videos.



**Delete all button:** Deletes all images and recorded videos in the image gallery.



**Restore button:** Restores the last deleted image or recorded video.

### Monitor Connection Overview

#### Transfer Toolbar

The transfer toolbar enables you to transfer images from the camera to the **Acquisition** interface or to the computer. The transfer toolbar displays when the camera supports the monitor connection.



**Transfer to ACQ button:** Transfers images from the camera to the **Acquisition** interface.



**Transfer to Hard Disk button:** Transfers images from the camera to the computer.

#### Select Patient Dialog Box

The **Select Patient** dialog box enables you to transfer images of the selected patient number to the **Acquisition** interface.

**Figure 3 Select Patient Dialog Box**

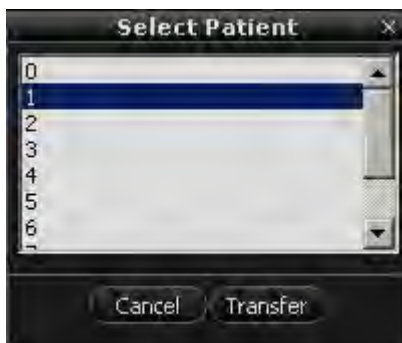

## Dialog Boxes Overview

### Image Processing Dialog Box

The image processing dialog box enables you to manage the image contrast and brightness.

Figure 4 Image Processing Dialog Box



**Brightness** button: Adjusts the brightness of the image.



**Contrast** button: Adjusts the contrast of the image.



**Scroll** button: Increases or decreases the brightness and contrast of the image.



**Reset** button: Clears all brightness and contrast changes made to the image.

### Tooth Chart Dialog Box

The **Tooth Chart** dialog box enables you to select tooth numbers associated with the image or video.

Figure 5 Tooth Chart

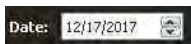

**Date** field: Displays the current date.



**Comments** field: Enables you to enter comments to be associated with an image or video.

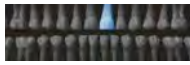

**Dental arch:** Enables tooth selection.



**Adult dental arch:** Enables tooth selection for an adult.



**Child dental arch:** Enables tooth selection for a child.



**Reset button:** Clears all tooth selections.



**Cancel button:** Cancels all tooth selections.



**Save button:** Saves tooth selections.

### Select a Format Dialog Box

The **Select a format** dialog box enables you to select the display format you want.

**Figure 6 Select a Format Dialog Box**



**Selections field:** Enables you to select the display format you want.



**Preview field:** Enables you to preview the selected display format.



**Cancel button:** Cancels the format selection.



**Open button:** Opens the format selection.

## Preferences Dialog Boxes Overview

The **Preferences** dialog boxes enable you to select the camera and acquisition software settings. Set up your preferences before using the camera.

### General Preferences

Figure 7 General Preferences



The **General Preferences** dialog box enables you to select the following options:

- **Language:** Select the menu language.
- **Tooth numbering system:** Select the tooth numbering system.
- **Frequency setting:** Select the local electric frequency.
- **Power off automatically:** Select the camera's automatic power off time, from 1-9 hours.
- **Power on automatically:** Enable/disable the camera's automatic power on feature for the camera's support monitor connection.
- **Capture sound:** Enable/disable the audio sound when an image is captured.
- **Record sound:** Enable/disable the audio sound when a video is recorded.



**Important:** Ensure that the proper frequency setting is selected for your region. The wrong setting can negatively impact image quality.



## Video Adjustment Preferences

Figure 8 Video Adjustment Preferences



The **Video Adjustment Preferences** dialog box enables you to select the following options:

- **Brightness Setting:** Select the video brightness setting.
- **Contrast Setting:** Select the video contrast setting.

## Tools Preferences

Figure 9 Tools Preferences



The **Tools Preferences** dialog box enables you to select the following option:

- **Create log file:** Save log files for service information.



# 5 Setting Up the CS 1200 Intraoral Camera

## Connecting the Camera to a Computer and Installing the Software

To connect the camera to a computer and install the software, follow these steps:

- 1 Connect the camera to the computer.

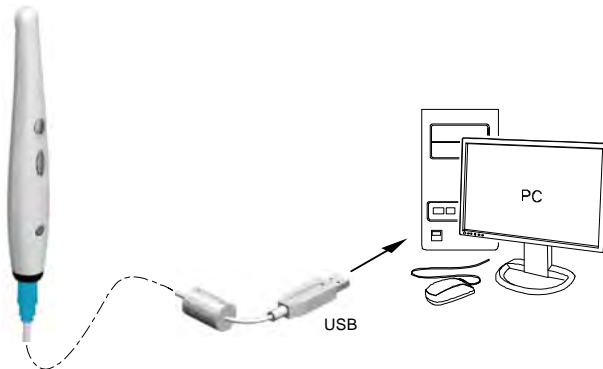

- 2 Insert the **CS Imaging Software** DVD in the DVD drive and install the software. See the **CS Imaging Software** documentation: *CS Imaging Installation and Configuration Guide (SM998)*, for more information.

To install the imaging software using a TWAIN interface, see your imaging software user guide.

- 3 Insert the **CS Intraoral Cameras Installation Wizard** DVD in the DVD drive. If the DVD does not run automatically, navigate to your DVD drive in Windows Explorer and double-click the **Launcher.exe** file.

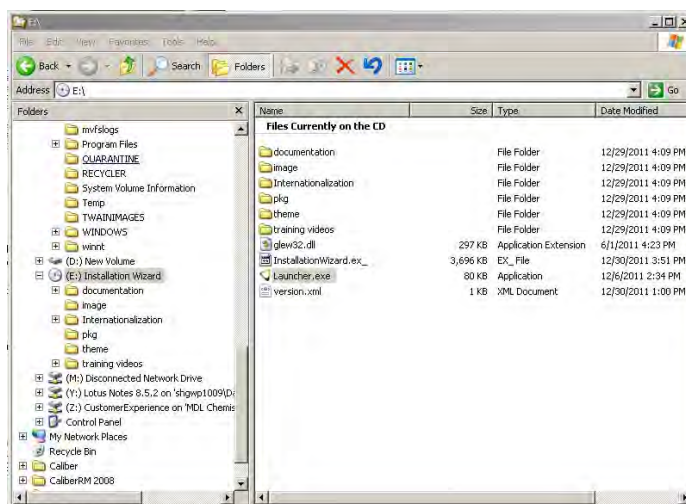

- 4 Follow the on-screen instructions to install the **Acquisition** interface and set up the camera. A prompt asking you if you want to install the software might display.

Check **Always trust software from "Carestream Dental LLC"** and click **Install**.

## Installing the Camera Holder

### Camera Holder Components Overview

Place the camera in the holder when you are not using the camera.

**Figure 10 Camera Holder Components Overview**

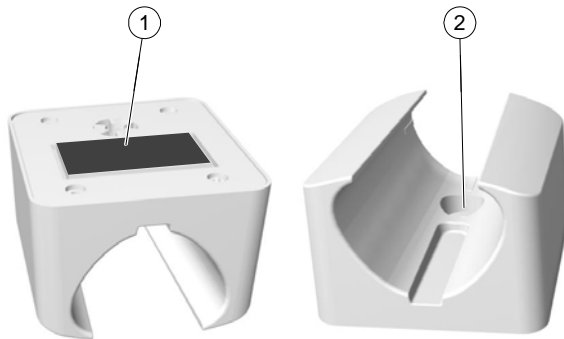

- 1 Adhesive tape
- 2 Opening to fasten the holder securely to the mounting surface using a screw

### Installing the Camera Holder

To install the camera holder, follow these steps:

- 1 Choose a clean area on the wall that you can access easily.
- 2 Clean the surface on which you are going to fasten the camera holder.
- 3 Remove the adhesive tape protection from the support (A).
- 4 Place the taped side of the camera holder on the clean surface (B) and press firmly several times for correct adherence. The maximum adherence is obtained after two hours.

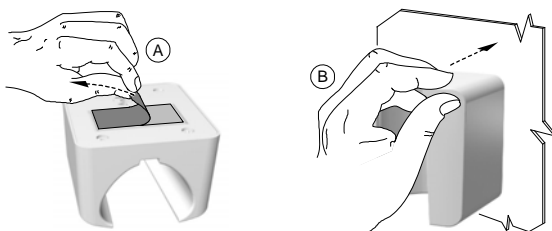



**Important:** You must avoid all stress on the camera holder during the first 2 hours.



**Important:** Adhesive tape can lose its adherence capability due to environmental and other factors. Check the adherence regularly to ensure that it is secure.



**Important:** Carestream Dental LLC is not responsible for accidents involving the camera falling due to loosening of the adhesive tape.



**Note:** The camera automatically goes into sleep mode when inserted into the camera holder or left idle for 1.5 minutes. To use it again, pick it up or press the **Capture** button.



**Note:** When the camera is idle for more than 3 hours (default), it powers off. To change the default automatic power-off time, see "[General Preferences](#)" on page 12.

- 5 For places on which you cannot use the adhesive tape, insert a screw through the appropriate hole in the camera holder to affix it to a solid surface.

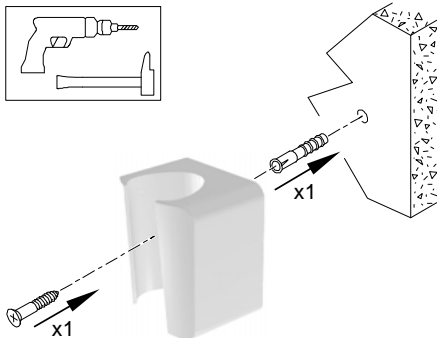







# 6 Getting Started

## Accessing the Acquisition Interface

To access the **Acquisition** interface, follow these steps:





- 1 In the **Imaging** window:
  - If you installed only the CS 1200 or you have installed the CS 1500 and/or CS 1600 camera before the CS 1200, click  or .
  - If you have installed a K 1000 camera before the CS 1200, click the arrow button on  or , and select the CS 1200 camera from the drop-down list.

The **Acquisition** interface is displayed.

- 2 Select your preference settings.

## Setting Up Preferences

Set up your preferences before using the camera. To set up the preferences, follow these steps:

- 1 On the **Acquisition** interface, click . The **Preferences** dialog box is displayed.
- 2 Click  to set the General preferences.
- 3 Click  to set the Video Adjustment preferences.
- 4 Click  to set the Tools preferences.

You can now capture images or record videos.

## Using the Imaging Software with TWAIN

### Starting the Imaging Software

To acquire an image using imaging software via TWAIN, follow these steps:

- 1 From your imaging software, such as Photoshop, open the **TWAIN** interface.  
For example, in Photoshop, go to **Import > Select Source**.

The **Select Source** window is displayed.



- 2 Select **CS Intraoral Camera 2.3 (32-32)** and click **Select**.
- 3 Open the **Acquisition** interface using the TWAIN interface; see the user guide for your imaging software.



**Note:** The software used for image acquisition must be compliant with TWAIN.

TWAIN has the following limitations:

- TWAIN does not support the video file or tooth comment feature within the **Acquisition** interface. The video file or tooth comment feature is disabled.
- After capturing images, click  to return to the imaging software interface. If the imaging software supports multiple image transfers, all images will be transferred. If the imaging software supports only a single image transfer, either the first or the last acquired image will be transferred.



**Note:** If the message **Camera setting changed, please restart your third party software** is displayed, you must restart the software and reopen the **Acquisition** interface.

## Setting Up Preferences

Set up your preferences before using the camera. To set up the preferences, see [“Setting Up Preferences” on page 19](#).

You can now capture images.



# 7 Recording Video and Capturing Images on a Computer

## Preparing for Acquisition

### Preparing the Camera

The protective sheath covers the camera and provides a sanitary shield for the patient. **Use a new protective sheath with each patient. Always discard the protective sheath after each use.** For additional protective sheaths, contact your dealer or the protective sheaths manufacturer.



**Important:** Use only the protective sheaths designed specifically for this camera.

To prepare the camera, follow these steps:

- 1 Make sure the window is clean by wiping it with a moist, lint-free cloth or lens tissue.
- 2 Place the protective sheath, paper side down, on a flat surface.
- 3 With the camera window facing down (A), insert the camera all the way into the protective sheath between the protective sheath's white tab and paper backing (B).

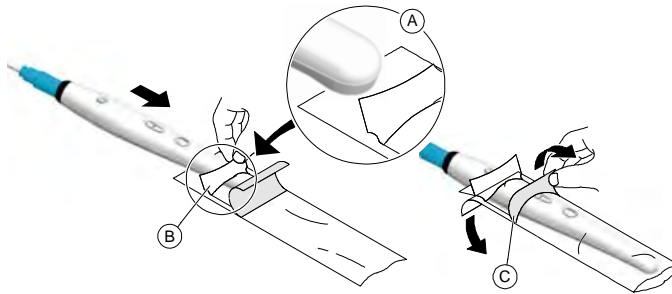

- 4 Hold the protective sheath in place on the camera by gently pressing the white tab against the camera with your thumb or finger.
- 5 Pull the blue tab on the front of the protective sheath straight down away from the camera (C) until the paper backing is pulled away. Discard the paper backing, leaving the clear plastic protective sheath on the camera.
- 6 Adjust the protective sheath if necessary. The end should be tight to prevent fogging or blurring of the image.





**Note:** Installing the sheath incorrectly has a negative effect on image quality.

## Acquiring Live Video or Images

### Accessing the Acquisition Interface

To access the **Acquisition** interface:

- If you use **CS Imaging Software**, click  or  in the **Imaging** window and select your camera.
- If you use imaging software via a TWAIN interface, see the user guide of your imaging software for details on opening the **Acquisition** interface.

### Recording or Viewing a Video

To record or view a video, follow these steps:

- 1 Press the ON/OFF button 3 seconds to power on the camera.

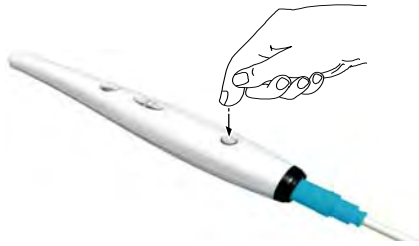

- 2 Hold the camera over the area you want to view. Live video appears on the **Preview** screen.
- 3 To record the video, on the **Acquisition** interface, click  to record and click again to stop the recording.

The video recording is displayed on the **Preview** screen of the **Acquisition** interface.

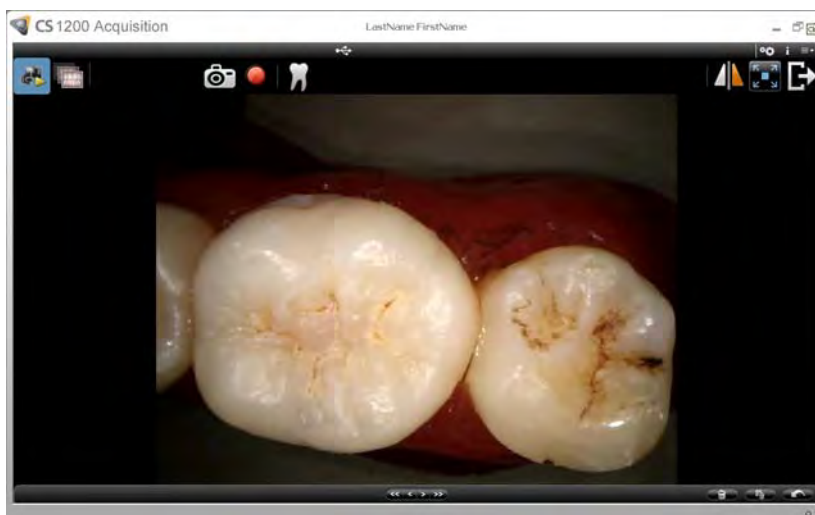

- 4 Use the video toolbar to view the recorded video (see ["Video Toolbar" on page 8](#)).
- 5 Use the image gallery toolbar to scroll through, save, or delete the recorded video (see ["Image Gallery Toolbar" on page 9](#)).

- 6 Click  to close the **Acquisition** interface and return to the imaging software interface. The recorded video is saved and displayed in the **Patient history**.
- 7 Remove and dispose of the protective sheath.

## Capturing and Viewing Images

To capture or view an image, follow these steps:

- 1 Press the ON/OFF button 3 seconds to power on the camera.

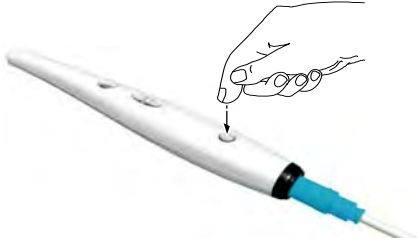

- 2 Hold the camera over the area you want to view. Live video appears on the **Preview** screen.
- 3 To capture an image, do one of the following:
  - Press the **Capture** button on the camera.

**OR**

- Click  on the **Acquisition** interface.

The image is displayed on the **Review** screen of the **Acquisition** interface.



- 4 Click  to access the **Tooth Chart** dialog box, select the relevant tooth, and type comments in the **Comments** field (see [“Tooth Chart Dialog Box”](#) on page 10).

The selected images are displayed and saved temporarily in the image gallery.

- 5 Use the toolbar to view the image (see [“Image Toolbar”](#) on page 8).

- 6 Press the **Review** button on the camera to review the images.

**OR**

Use the image gallery toolbar to scroll through, save, or delete the images (see [“Image Gallery Toolbar”](#) on page 9).

- 7 Click  to close the **Acquisition** interface.

The images are saved and displayed in the **Patient history**.

- 8 Remove and dispose of the protective sheath.



**Note:** The camera automatically goes into sleep mode when inserted into the camera holder or left idle for 1.5 minutes. To use it again, pick it up or press the **Capture** button.



**Note:** When the camera is idle for more than 3 hours (default), it powers off. To change the default automatic power-off time, see [“General Preferences”](#) on page 12.

# 8 Maintenance

## Cleaning and Disinfecting the Camera

You must clean and disinfect the camera and accessories regularly.

The camera is not delivered in disinfected condition. To ensure maximum hygienic safety for the patient, carefully follow the instructions to disinfect the camera before use.



**Important: For information on cleaning and disinfecting, see the Safety, Regulatory, and Technical Specifications User Guide.**



# 9 Troubleshooting

## CS 1200 Troubleshooting Instructions

Problem Description	Action
No image is displayed on the screen.	<ul style="list-style-type: none"> <li>• Make sure the power indicator LED on the camera is green.</li> <li>• Disable the firewall and the antivirus software, then try again. If an image is displayed, perform the necessary adjustments to the firewall and the antivirus software settings before opening the <b>Acquisition</b> interface again.</li> </ul>
The camera captures an image but does not display live video or record video.	Make sure the computer meets the minimum system requirements.
After installing the camera, other USB devices do not work correctly.	<ul style="list-style-type: none"> <li>• Plug the camera into a different USB port (for desktops, it is recommended to use the rear USB ports).</li> <li>• If the camera is directly connected to the computer, try using a USB hub. If using a USB hub, try connecting the camera directly to the computer.</li> </ul>
The camera is not active within the <b>CS Imaging Software</b> interface. The camera icon is “grayed out.”	<ul style="list-style-type: none"> <li>• In the <b>CS Imaging Software</b>, go to <b>Options -&gt; Preferences -&gt; Camera</b>. Make sure that <b>Use a video capture source box</b> is checked.</li> <li>• From the Windows Control Panel, select <b>Add or Remove Programs</b> and make sure that <b>CS Acquisition Interface</b> is displayed.</li> <li>• Reinstall the <b>CS Imaging Software</b> and the <b>Acquisition</b> software. See <a href="#">“Connecting the Camera to a Computer and Installing the Software” on page 15</a> for more information.</li> </ul>
The colors of the live video or captured images are not accurate.	<ul style="list-style-type: none"> <li>• On the <b>Acquisition</b> interface, click  and select <b>Video Adjustment Preferences</b>, then adjust contrast and brightness.</li> <li>• Check the contrast and brightness of the computer monitor.</li> <li>• Reboot the camera.</li> </ul>
Cannot enter tooth number in <b>Tooth number</b> option.	Make sure the correct country/region for the tooth number standard is selected in the <b>General Preferences</b> .
Blurred image.	Replace the sheath. See <a href="#">“Preparing for Acquisition” on page 21</a> for more information.
Live video/recorded video is choppy or lagging.	Make sure that the graphics card is using the latest drivers. Visit the website of the graphics card manufacturer to learn how to update the drivers.

Problem Description	Action
<p>Glitches with the display in Windows Vista or 7. For example, a "picture in picture" effect in live video or a flashing screen when dragging windows within the <b>Acquisition</b> window.</p>	<ul style="list-style-type: none"> <li>• Click <b>Start--&gt;Control Panel (View by Large Icons)--&gt;Performance Information and Tools</b>, and select <b>Re-run the assessment</b> to refresh the rating score.</li> <li>• Make sure that the graphics card is using the latest drivers. Visit the website of the graphics card manufacturer to learn how to update the drivers.</li> </ul>
<p>Connection failure between the camera and the computer after computer standby.</p>	<p>Reboot the camera and the <b>Acquisition</b> interface.</p>
<p>For the monitor configuration, images cannot be found in drive <b>C:\</b> after they are exported to the disk from the camera.</p>	<p>The transferred images are saved in folder <b>C:\Users\<user account="">\AppData\Local\VirtualStore</user></b>. This folder is hidden by default. Change the default setting for the hidden folders in your Windows operating system.</p>
<p>Tooth comments cannot be displayed correctly after they are exported to the <b>CS Imaging Software</b>.</p>	<p>Make sure that the language used for the tooth comments is the same as the language option in the <b>CS Imaging Software</b>.</p>
<p>Firmware upgrade fails when the <b>Acquisition</b> interface is opened.</p>	<p>Run your imaging software as an administrator.</p>



# 10 Contact Information

## Manufacturer's Address



**Carestream Dental LLC**  
3625 Cumberland Boulevard, Suite 700  
Atlanta, GA USA 30339  
[www.carestreamdental.com](http://www.carestreamdental.com)

## Authorized Representatives

### Authorized Representative in the European Community



Trophy  
4, Rue F. Pelloutier  
Croissy-Beaubourg  
77435 Marne-la-Vallée, Cedex 2  
France

### Importer for European Union

Carestream Dental Germany GmbH  
Hedelfinger Str. 60  
70327 Stuttgart  
UST ID Nr. DE815716368  
Fax. No. 0711 20 70 7331  
Handelsregister Nr.; HRB 760305  
WEEE-Reg.Nr.: DE90742102

### Authorized Representative in Brazil

Carestream Dental Brasil Eireli  
Rua Romualdo Davoli, 65  
1° Andar, Sala 01 - São José dos Campos  
São Paulo - Brazil  
CEP (Zip code): 12238-577

For more information, visit: [www.carestreamdental.com](http://www.carestreamdental.com)

To give documentation feedback, visit: [www.carestreamdental.com/documentationfeedback](http://www.carestreamdental.com/documentationfeedback)